

WUXI LINGDE MICROELECTRONICS CO., LTD.

---

# LD902GL Display

## Instruction Manual

### V1.0

2018/5/23



The instrument-LD902GL is simple and beautiful with the unique design of scientific ergonomic curve. The LED is not only clearly visible in the sunlight but also displayed with soft light under the night mode that makes riding safety.

## About our Manual

Please read the manual of LD902GL carefully before taking a ride for a better performance.

## Size



## Instruction to display interface

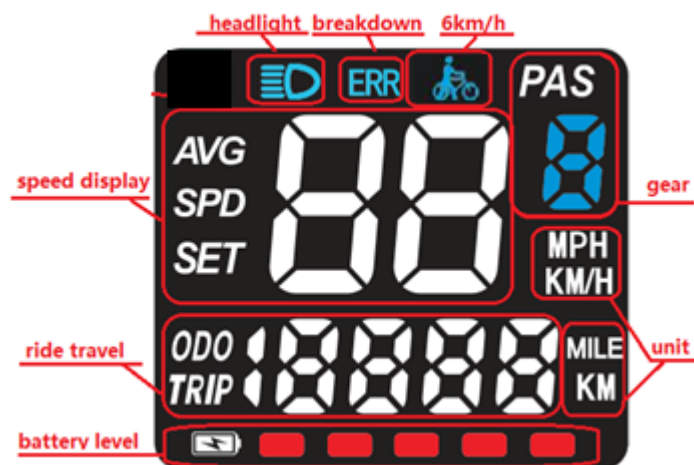

## Model and parameter

### LD902GL

Five assisted power display

Level 0 to 9 assisted power display

RS232

Support 24V,36V,48V

## Installment guide

- 1.Fix the instrument on the handlebar and adjust a appropriate angel.**
- 2.Install the set screw from the bottom of instrument fixed on the handlebar. It is advised to install the screw manually.**

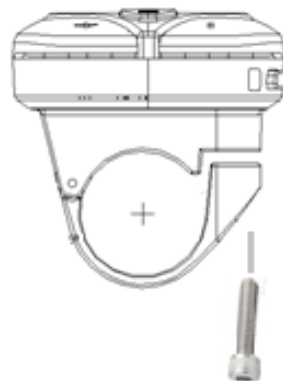

- 3.Please insert the connectors of instrument and the connector of controller on the occasion of power off.**

## Definition of button

There are 4 buttons on the instrument, including the power/mode (M), up(+), down(-).

## Routine operation

### turn on/ off

**ON:** press the button of M for a long while on the occasion of power off, and enter the password if any, then the instrument starts working, offering the power to controller and working well with controller after 3 seconds.

**OFF:** press the button of M for a long while on the occasion of on, you can turn off without wasting the power. At this time, the current is less than 1uA.

### Assisted Power Select

Press the button of + or - for a short while, you can change the output power of motor. The default power ranges from level 0 to level 5, 1 the lowest, 5 the highest. When the instrument is on, the default level is 1 just like the red box in picture below.



1<sup>st</sup> gear



9<sup>th</sup> gear

## Power Assisted Walk

After holding the button of DOWN for 2 seconds, electric bicycle will come into the mode of power assisted walk, keeping an even speed at 6 kilometers per hour. The gear position displays the speed per hour. Release the button to stop the mode immediately.



Notes:

The function works out at the situation of pushing electric bicycles. Do not use it when riding.

## Turn on/off headlight

Press the key (+) to turn on the headlight, press the key again to turn off it.



## Display of handover

The instrument will display the current speed and ODO on the occasion of normal work without breakdown. When pressing M, you can switch to AVG and TRIP, with the corresponding indicator light on.



## Capacity display

When voltage is high, 5 battery segments will be alight; when only 1 battery segment is alight, it means low power and needs to be charged.



## Error code display

When something is wrong with the electric control system, the ERR light will be alight and speed position will show the error code.



Only when the fault is excluded can it exit the interface. If the fault happens, the bicycle cannot be ridden.

## Parameter setting

In setting menu: You can do settings when pressing + and -, and entering the password 1234 on the occasion of power on and normal work of the parking instrument, just like SE and number 1 in the picture below. (Please note that some types do not have password) You can set the number password by press + and - for a short while. You can set the next number password by pressing M for a short while. Do the same work till entering the correct password and coming into the interface of setting items.

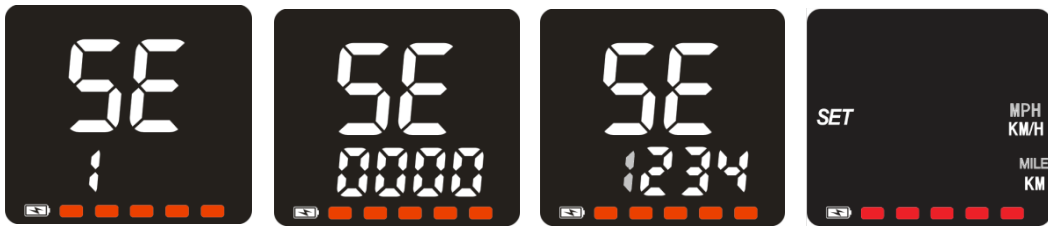

**EXIT Menu:** You can exit the setting menu by pressing M for a long while in any setting menu. Besides, you can exit the setting menu automatically by pressing M for a short while and switching all the setting items.

**SET1(unit setting):** When entering the setting menu, the default setting is SET1. You can switch the mile and kilometer by pressing +/-, with the switching of speed and trip at the same time and corresponding indicator light on. You can quit the interface by pressing M to set the next item for a short while or pressing M for a long while.

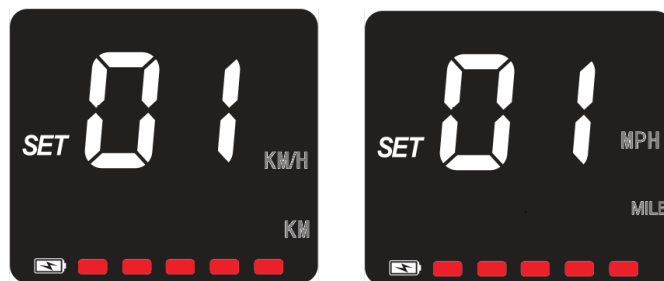

**SET2(speed limited):** When in SET2, the factory default limited speed of the instrument is 25km/h. The effective limited speed ranges from 10 km/h to 41 km/h by pressing +/- . It doesn't work if over the range. You can quit the interface by pressing M for a short while to set the next item or pressing M for a

long while.

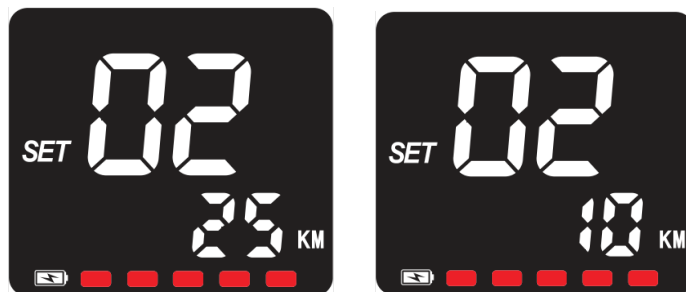

**SET3(Wheel diameter setting)**when in the mode of SET3, the default wheel diameter matches the whole bike, so it is not advised to change it. The wheel diameter can be changed by pressing the key of +/-, including 16 20 22 24 26 700C 28. You can enter the next mode by pressing the key of M.

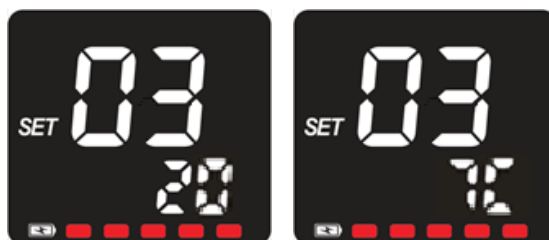

**Set4 (magnetic steel of speed measuring)**:when in the mode of set4,the default magnetic steel of speed measuring matches the whole bike. The default value is 1 if no exclusions. The number is not advised to changed . You can change it by pressing the of +/- . 1 and 6 can be chosen. You will go into the next setting by pressing the key of M for a short time.





**Set5(the total gear setting):** when in the mode of set5, the default total assisted gear is 5. You can change it by pressing the key of +/-, with the maximum 9 and the minimum 1.ou will go into the next setting by pressing the key of M for a short time.



## **Quality Warranty**

### **一、 warranty coverage:**

**1、 When the malfunction is caused by the quality of the product itself under regular use condition, our company will be responsible for it under guarantee.**

**2、 24 months from the delivery time of the display out of the factory.**

**二、 The following conditions are not covered by the warranty.**

**1、 The shell is open.**

**2、 The connectors are broken.**

**3、 The shell is scratched or damaged after out of factory.**

**4、 The lead wires from the display are scratched or broken.**

**5、 Damages are caused by irresistible (e.g. fire, earthquake, etc) or natural disasters (such as lightning, etc.);**

**6、 The product exceeds the warranty period.**

## Wiring Diagram

The display is matched with 5-waterproof wire and the wire definitions are as below.

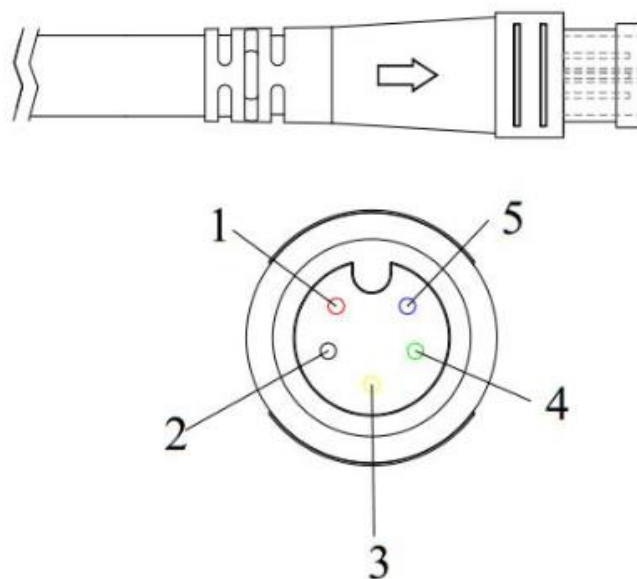

number	colour	function
<b>1</b>	Red ( <b>VCC</b> )	Power B+
<b>2</b>	Black( <b>GND</b> )	Power B-
<b>3</b>	Yellow( <b>TX</b> )	Gorge line: sending message
<b>4</b>	Green ( <b>RX</b> )	Gorge line: receiving message
<b>5</b>	Blue ( <b>K</b> )	Electric door look offer weak power to other equipment

**Note:** Users cannot see the color of the internal wiring because of the water proof connector.